

# PURGENVENT™

## Model 7920AI/7925VI

QUALITY COMPONENTS FOR FIRE SPRINKLER SYSTEMS

### Air Venting Valve Water Collection Assemblies

AGF PURGENVENT water collection assemblies are designed to trap the atomized mist that may be expelled by the venting valve while releasing excess air. When the Model 7920AI collection valve reaches capacity (1.2 oz/35 ml) an audible alarm sounds and a visual LED flashes. Once the collection valve is emptied the alarms will reset. The Model 7920AI can be powered by a 9V battery (default) or hardwired. A plug-in option is also available (sold separately). The Model 7920AI may be wired to the fire control panel or BMS for remote notification. When the Model 7925AI collection valve reaches capacity (1.2 oz/35 ml) a visual float indicator rises from the top of the collection valve (approximately 2 $\frac{5}{16}$ ""). When the visual indicator is fully extended the collection valve needs to be drained. The float indicator will lower as the collection valve is emptied.



### Models

Part Number
7920AI

### Features

- Naturally Aspirating
- Audible and Visual Alarms
- Automatically Resets when Emptied
- 1" MIPT x FIPT Water Collection Valve
- Battery, Hardwired, or Plug-In Power Options
- Union Connection
- Fire Panel and BMS Compatible

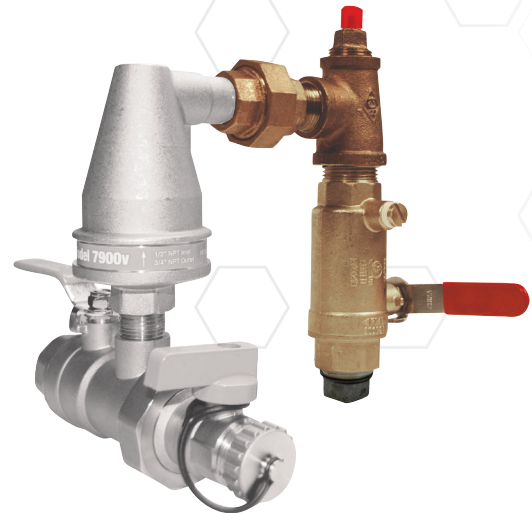

### Models

Part Number
7925VI

### Features

- Visual Indicator
- 1" MIPT x FIPT Water Collection Valve
- Union Connection
- Easy to Install



**Dimensions**

**M7920AI**

**M7925VI**

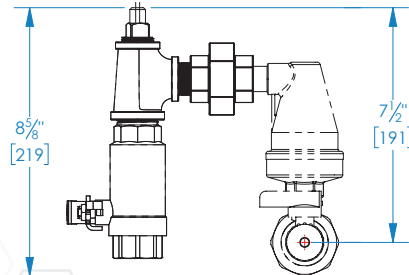
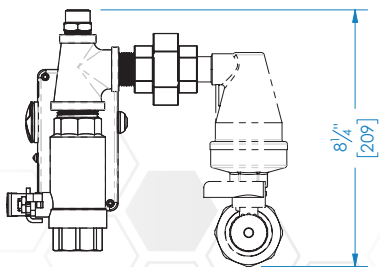
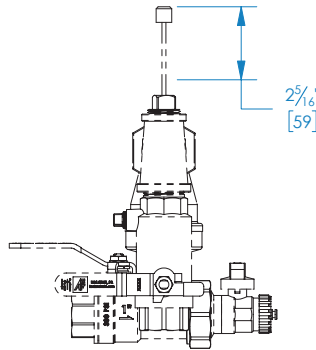
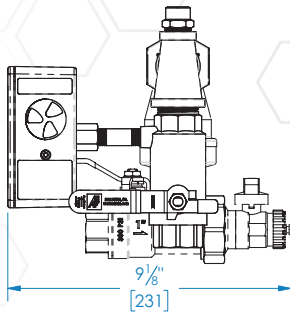
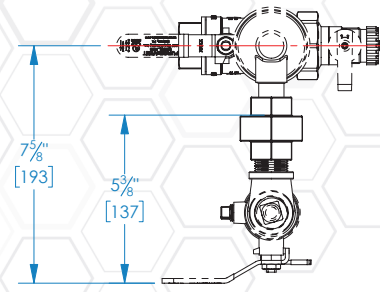
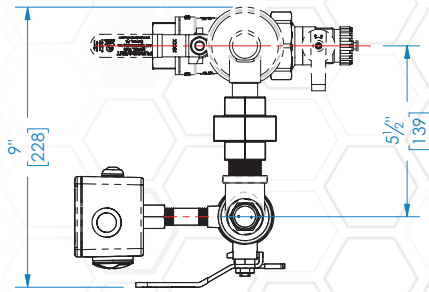

For use on wet fire sprinkler systems.

**Valve Size**

1"

**Connections**

3/4" Union

**Installation Orientation**

Horizontal with 7900V in Upright Position

**Electrical Requirements**

M7920AI: 9V Battery, 12-24VDC,

120VAC Plug-In

M7925VI: None

**Materials**

Collection Valve Body ..... Brass

Handle ..... Steel

Ball.....C.P. Brass

5100AL ..... Aluminum

**Rating**

175 PSI

USA Patent #10391344 and Other Patents Pending



**AGF Manufacturing Inc.**  
100 Quaker Lane, Malvern, PA 19355

Phone: 610-240-4900  
techsupport@agfmfg.com

[www.agfmfg.com](http://www.agfmfg.com)

**Job Name:** \_\_\_\_\_

**Architect:** \_\_\_\_\_

**Engineer:** \_\_\_\_\_

**Contractor:** \_\_\_\_\_